

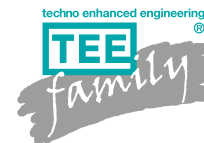

CREATIVITY, TECHNOLOGIES
AND MATERIALS



*Partner
for top
performance*



High-performance
electrical connections
www.techno.it

MADE IN ITALY



High-protection solutions



In-line Circular joint connectors

Ideal for connections in small spaces and with a high degree of protection (IP68).



Quick, Re-accessible and Compact

Using the fewest number of components, we ensure that the product is installed in an easy way and in the least possible time.

Totally resin and gel-free, our TEETUBE® solutions are re-accessible even after long operating periods.

Availing ourselves of an innovative design and maximum precision in thermoplastic injection, we realize solutions which are considerably compact, with a high number of poles.

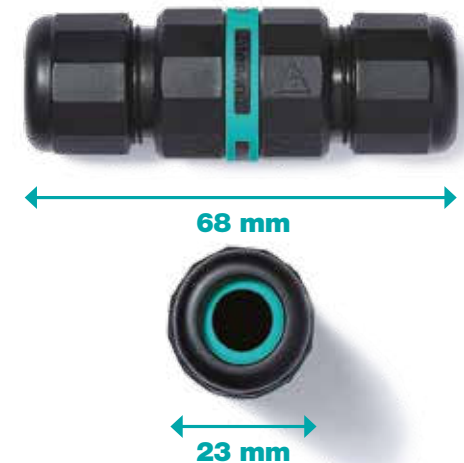

High-protection solutions



Gasket co-molding

The quality of our materials, innovative proprietary technologies and an accurate analysis of the operative conditions of application allow us to realize and test solutions for electrical connections under the most extreme conditions. Therefore we have decided to supply the market with a revolutionary solution aimed to eliminate the resin sealing of boxes and connectors: **to mold the entire connector in only one solution.**



High-quality materials

UL94 V0/V2 (f1) materials are suitable for underground installation and guarantee reliability over time.

Products tested up to 10 years.

UV radiation resistant

UV radiation resistance test according to EN60079-0. Light ageing method (ISO 4892-2). Duration 1000 hours. Electrical insulation test up to 3.75kV.

Anti-leakage gaskets

Perfect chemical-mechanical adherence of gaskets which guarantee robustness and reliability in water tightness. **No more installation faults.**

Resistance to permanent immersion (IP68)



High-protection solutions



No more condensation: completely insulated and sealed

Under particular environmental conditions, the accumulation of moisture inside the cable can cause the malfunctioning of electrical devices. The ventilation of the device is not often possible, especially when there is water, debris or in very small spaces. In this case the electrical connection is fundamental to ensure the reliability of the system.



Reliability guaranteed under extreme conditions

The special anti-moisture barrier prevents the damp inside the cable from entering the connection and proceeding towards the device installed. TEETUBE® connectors are ideal for LED applications with the presence of water and debris (e.g. flooded junction boxes).



LED lighting, architectural, walkable, water submersion, fountains and swimming pools, trade fair stands, lighting displays, big areas.

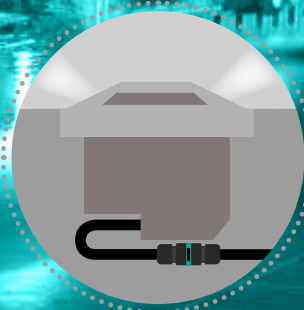

High-protection solutions



Useful for total protection

TEETUBE® connectors can be used in the most various situations, for example in the connection of power and heating cables, as a protection of electronic circuits, in data and optical fiber connections, in motors and pumps.



Simplified installation:

Pre-wired solutions. It is not necessary to open the box and realize complex wiring.

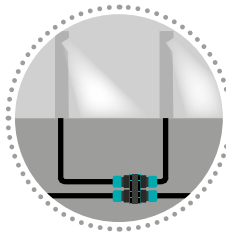

Submersible pumps and engines. Connectors and junctions IP68, resistant to moisture.



Wiring in shipbuilding and cooling containers.



Heating cables connection.

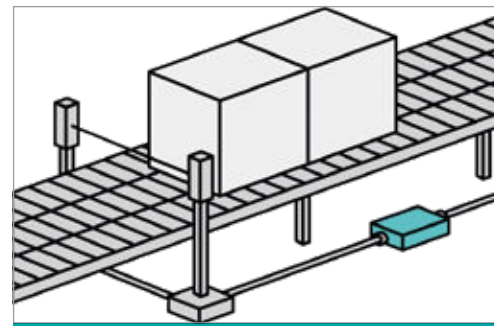

Quick connection junctions for industrial machines.

High-protection solutions



Quick plug&socket connectors

High-performance cable, wall mount and special connectors (IP68).



Robust and safe

The quick bayonet coupling junction ferrule with **safety lock-unlock system** guarantees higher resistance to vibrations and mechanical stresses (**guarantee of electrical continuity**). The disconnection is possible only by the use of a tool to prevent accidental displacement.

Maximum resistance to tensile stress

Under adverse installation conditions (e.g. heavy embossed cables, strong impacts, vibrations, etc.), a special cable block-system ensures perfect resistance to stresses (e.g. tensile stress).



Powerful and compact

The TEEPLUG® family is characterized by quick plug&socket connection solutions up to 25A 400V. Their compact dimensions are a strong point as an alternative to big industrial sockets with their electrical characteristics being the same.



Total protection

To ensure better seal, two gaskets have been co-molded on the diameter and on the bottom of the connector to prevent water and dusts from penetrating it. The gaskets are anti-leakage.

IP68



High-protection
solutions



Maximum efficiency in installation and maintenance

The plug&socket connectors and quick junction boxes constitute a reliable modular interconnection system which is necessary to guarantee flexibility and quickness in the configuration of a more and more advanced plant. **Reduction of cost of the product installed.**



Lighting of the F1 circuit in Singapore with TH405 connectors.

Public lighting, urban furniture, smart city, CCTVs, data centers, electric signs, car charging stations, etc.

Our materials do not contain sulfur which has a negative effect on the LED lifespan.



High-protection solutions



Dimensions that make the difference

Compact screw wire connectors meet the most demanding needs of connections in small spaces.



Ultra flat connector.

It is the only 4mm thick connector IP67 on the international market. It has been specifically designed and produced to be used in floor heating plants.

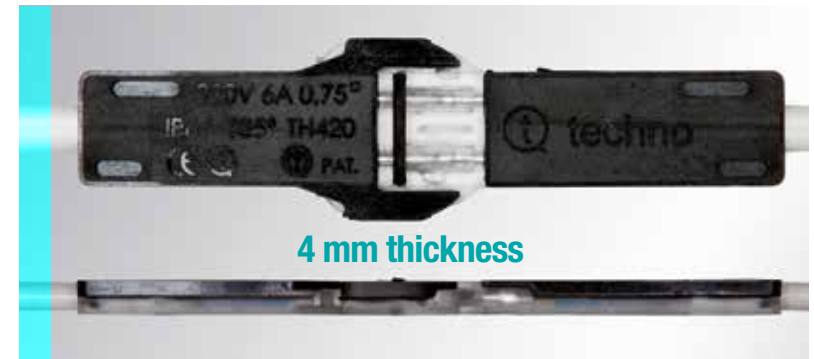

-60%
Faster
installations

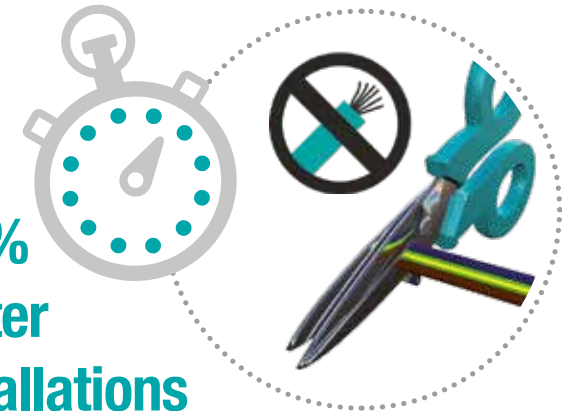

Quick screw wire and piercing connectors

The wire does not need to be peeled. It is enough to cut the wire and insert it into the wiring terminal. The golden colour screw identifies the insulation piercing connectors. We have available also connectors with standard screw terminal, metal and spring terminal.

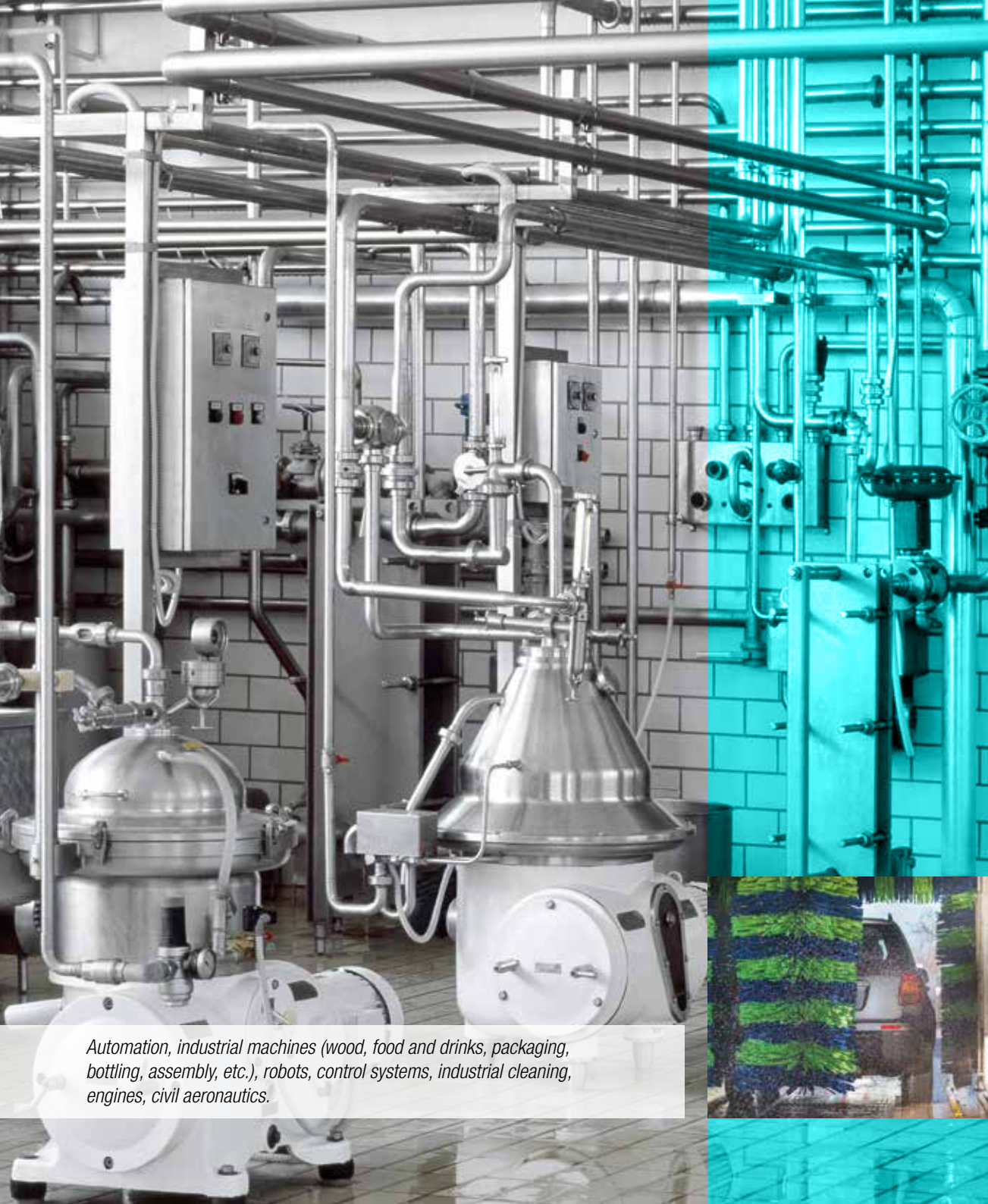

Reliable under extreme conditions

We rely on materials and productive technologies of excellence. We perform stress tests on our products, in addition to the ones provided for by law, to obtain an extremely high level of resistance to moisture, water, dusts and aggressive chemicals. UL94 V2/V0 Yellow Card materials: their exceptional mechanical, temperature and temperature gradients resistance increases the advantages of use further in many sectors.

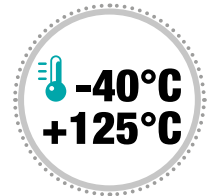

Automation, industrial machines (wood, food and drinks, packaging, bottling, assembly, etc.), robots, control systems, industrial cleaning, engines, civil aeronautics.



High-protection
solutions



Junction boxes and current distributors

Junction boxes with terminal blocks and plug&socket connectors for quick and flexible installations (IP68).



Attention to minute details

The co-molding gasket guarantees fail-safe installations. The connection hinge between the top and the bottom, obtained directly from the molding of the product, simplifies the installation activities. Cable glands with milled claws built in the box allow the installation of small-section cables.



High-protection solutions



Protected and compact for maximum versatility

Junction boxes approved up to IP68 guarantee water and dust proof connections without the use of resin or gel.

The boxes are re-accessible thanks to their compact dimensions, they are particularly suitable for connections in small spaces or containing electronic and electromechanical components.

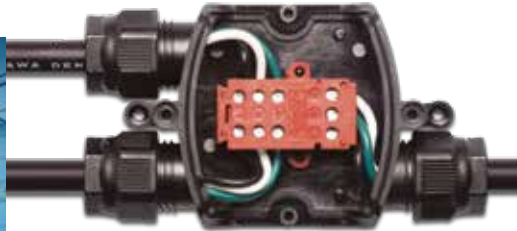
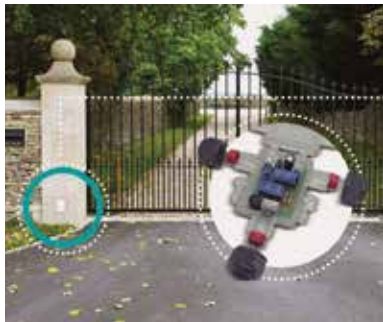
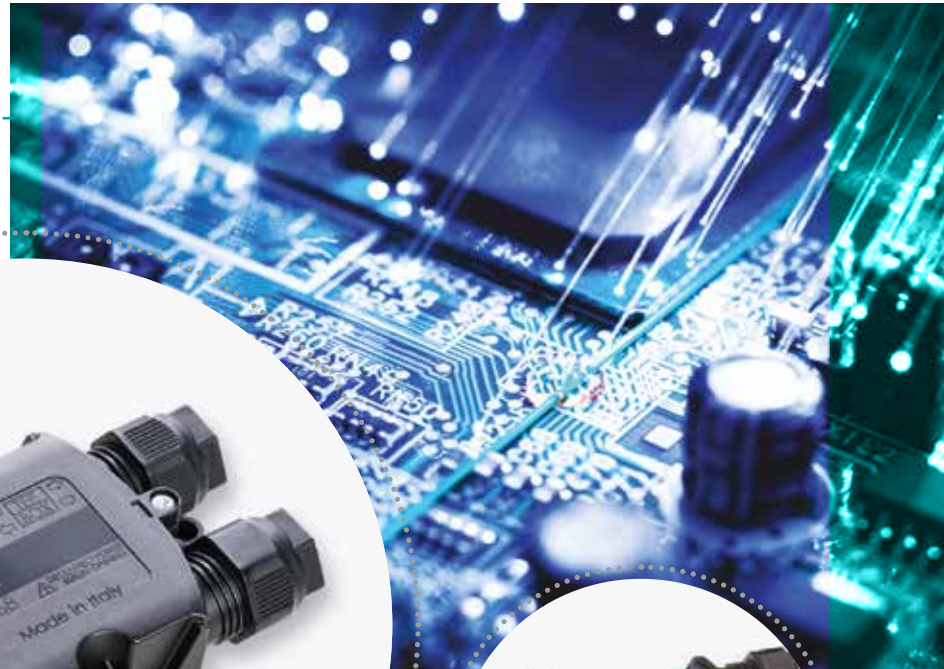

Residential and industrial electrical installation, junction boxes, gates and doors automation, CCTVs, heating/air- conditioning.



The highest performance in small space



Resistance to external agents (EN60529). In addition: ageing test in air with ozone concentration (ISO1431-1).



Resistance in saline environment - Corrosion test (EN60068-2-11:2000).



Resistance to impact (NEMKO - EN62262:2002). IK08 and IP68 tests satisfactory even after conditioning in hydrochloric acid (HCl) for 168 hours at 70°C (pH 4,5 and 3,5). Available versions with IK10.

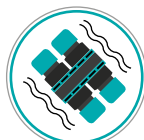

Resistance to vibrations (DEKRA - EN 60068-2-6; RINA RULES 2011 Pt C, Ch 3, Sec 6).



Resistance to flame. Use of materials reinforced with fiberglass UL94 V0/V2 (f1). Glow-wire 850°C/960°C.



Realized with materials compliant with the most rigorous Reach/RoHs regulations.

Upon request: low-smoke materials, EMC materials, resistant to ammonium versions. Search for materials and internal laboratory tests upon customer's specification.

Water treatment, monitoring, submersible pumps, energy distribution, petrol stations, mines, processing plant, irrigation, agriculture and cultivation, greenhouse.



Resistant to hydrocarbons (tested according to ISO1817:2001)



High-protection
solutions



Higher flexibility in the configuration of complex plants

3 and 4 ways electrical current distributors (pre-wired boxes with plug&socket connectors) designed to speed up the connection and disconnection of electrical networks and devices of various kind. The access to the terminal block inside the box is not required: it takes advantage of the simplicity and flexibility of a plug&socket connection.

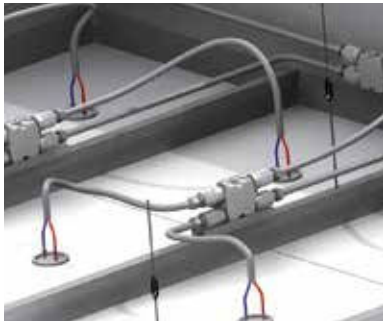

*Railway, tram, underground, bus,
navigation, shipbuilding, marine lighting,
yacht, caravan, light signaling, cable car.*



Innovative cable glands in co-molding

High-protection cable glands (IP68) for quick cable tying.

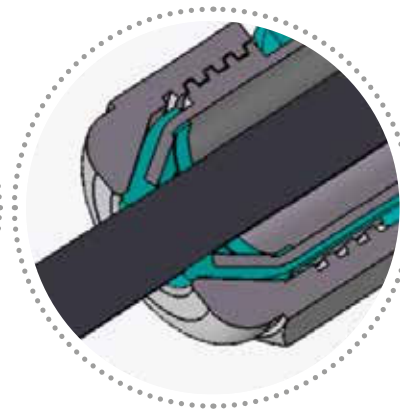

Rigorously reliable

Attention to details

The protective rubber is co-molded also where the cable gland is in contact with any supports. This gives it further reliability and safety, avoiding the use of OR on the thread of the cable gland.

The internal circular rubber crown ensure perfect tightness on the cable. A cable grommet is not needed anymore. Water tightness is guaranteed even in case of excessive nut tightening.

**max
55N**

Approved according to **EN50262**.
Cable tensile test **max.55N** passed.

**-50m
(5bar/1h)**

IP68



More quickness

The use of the TEEGLAND® cable gland allows a considerable saving on installation time. The fastening of the cable and the installation of the cable gland on the panel take only 2-steps and less than 8 seconds.

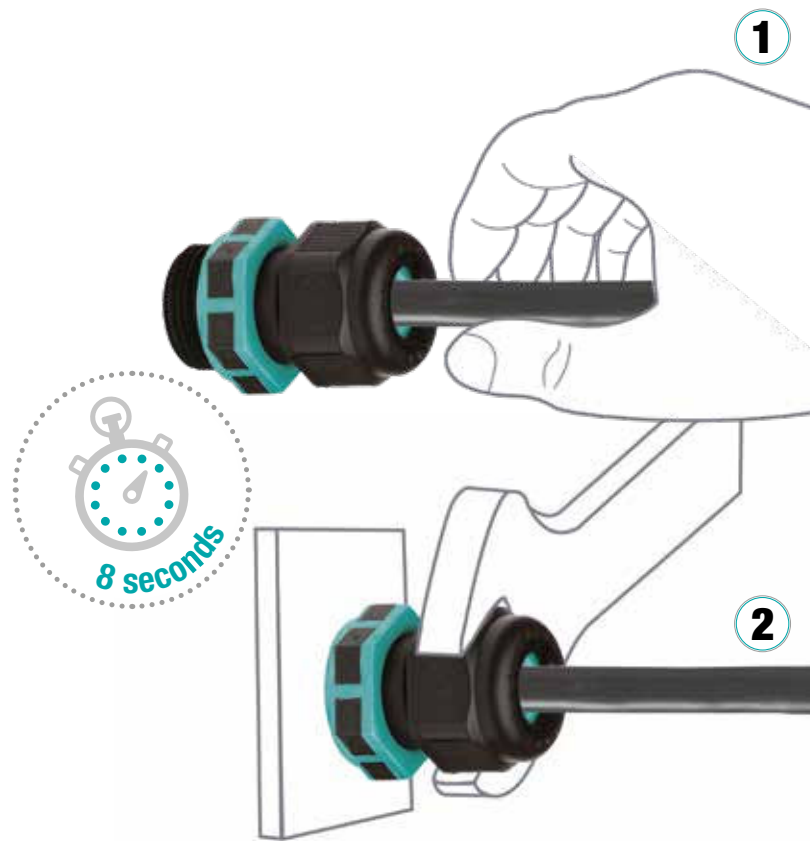

Fewer assembly faults

The co-molding of the rubber on the techno polymer ensures perfect installation compared to standard cable glands, where the detachment or the wrong position of the gaskets can impair its functioning. The rubber adheres chemically and mechanically to the plastic body and guarantees valid protection from external agents (IP68).

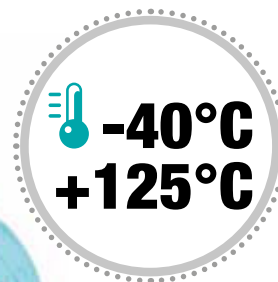

Engines and pumps, heating, air-conditioning, ventilation, industrial refrigerators, SPA, hydro-massage, vending.



Compact circular connectors

Individually usable or with TEETUBE® circular joint connectors.

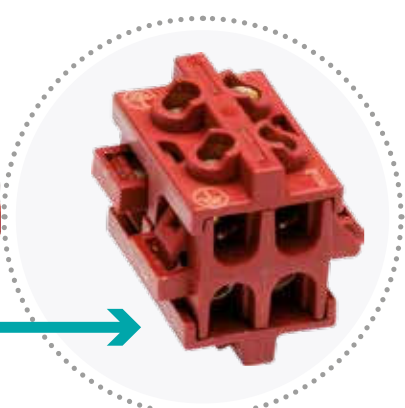
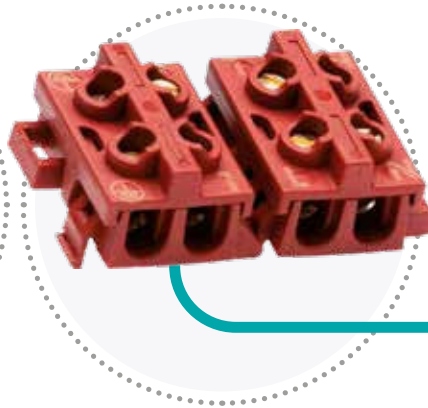

Modular and compact

Circular connectors, more compact than standard terminal blocks with the same number of poles.

Useful and versatile

The 4-way terminal block with a hinge makes cable wiring easier in particular situations such as automatic screwing in an industrial process.

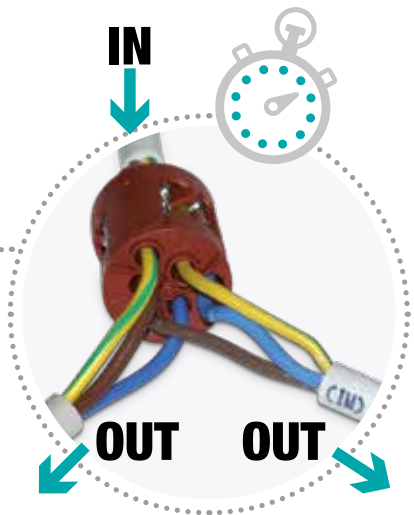
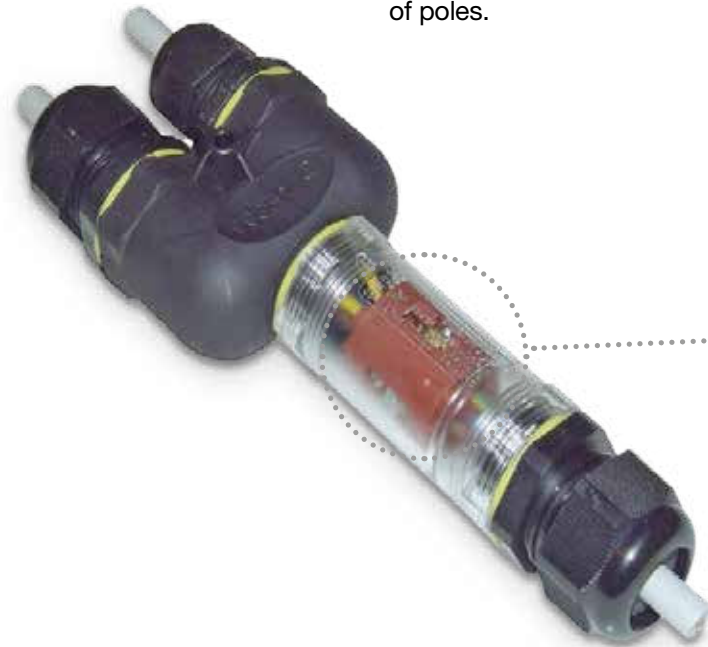

Connection solutions



Compact linear connectors

Individually usable or with TEEBOX® junction boxes.

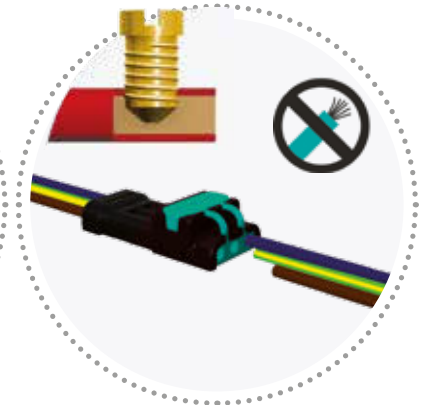
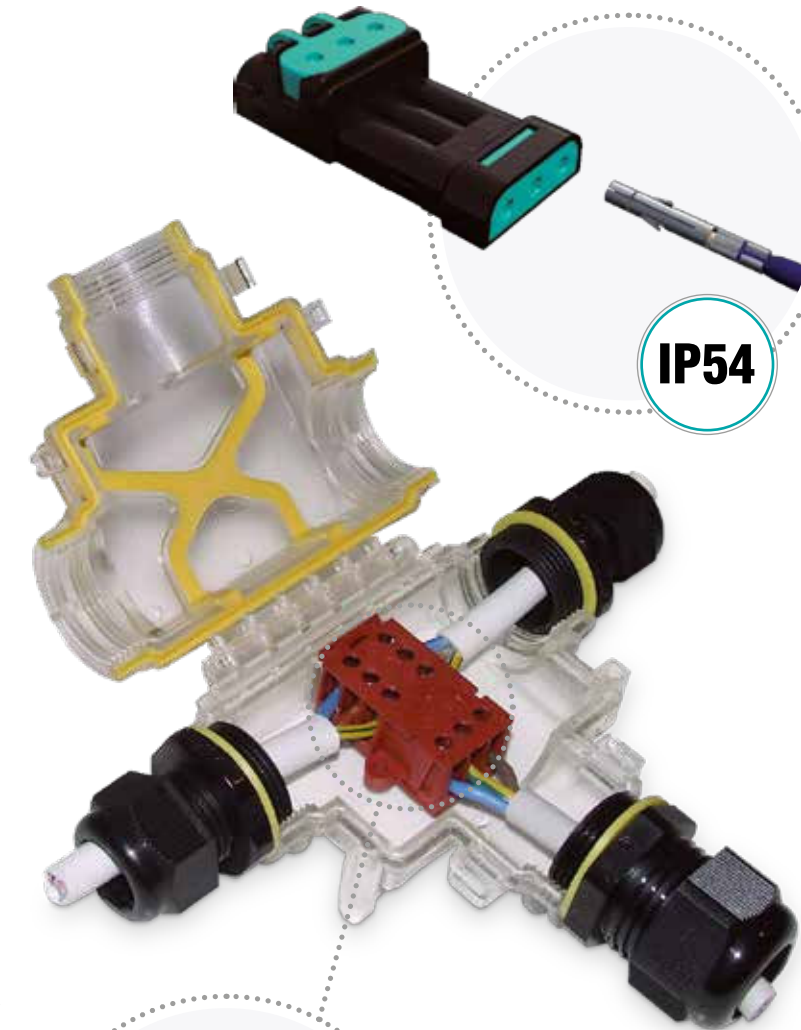
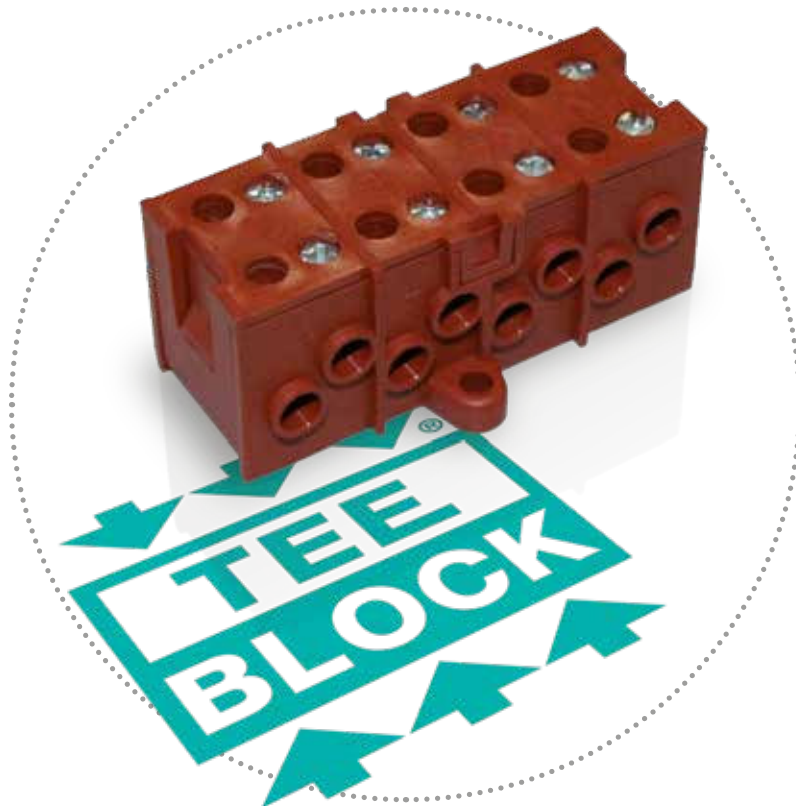

Reduction of process costs

New connector TH112(IP54). Quick and safe wiring for manufacturers of machinery through the addition of crimps. Cable cutting without peeling for technicians. Reduction of cost of the product installed, quickness and safety thanks to an innovative insulation piercing system.

Quick wiring

Thanks to a simple internal polarity connection system, there will be no need to twist the three strands of wire anymore. It will be enough to seat them individually in their apposite position in the terminal block to guarantee the correct connection of the poles. The plant will work in complete safety with a considerable advantage in terms of simplicity and quickness of installation.

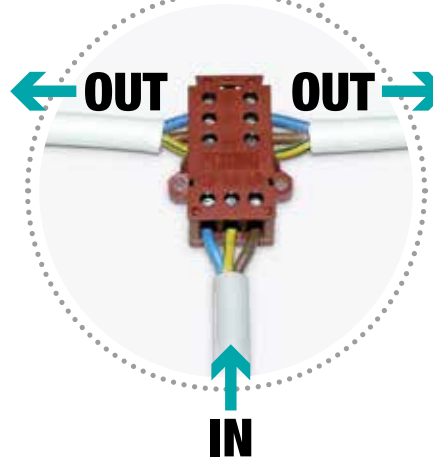

High-performance electrical connections TEEfamily[®] IP68

Fixed connectors (re-accessible)

Plug&Play connectors

In-line connectors



	TH391	TH390	TH400	TH110
Number poles ⁽¹⁾	2 4 poles	2 3 poles	2 6 poles	2 3 poles
Wire cross-section	0.5 - 4.0 mm ²	0.5 - 4.0 mm ²	0.5 - 6.0 mm ²	0.5 - 2.5 mm ²
Outer cable diameter ⁽²⁾	7.0 - 13.5 mm	7.0 - 13.5 mm	7.0 - 20.0 mm	5.0 - 9.0 mm
IP protection degree	IP68/IP69K	IP68	IP68/IP69K	IP44

	TH381	TH387	TH384	TH405
Number poles	2 poles	2 5 poles	2 3 poles	2 6 poles
Wire cross-section	0.25 - 1.0 mm ²	0.25 - 4.0 mm ²	0.5 - 4.0 mm ²	0.5 - 4.0 mm ²
Outer cable diameter ⁽²⁾	5.8 - 6.9 mm	7.0 - 13.5 mm	7.0 - 12.0 mm	7.0 - 14.0 mm
IP protection degree	IP68/IP69K	IP66/IP68	IP66/IP68	IP68

Junction connectors



3 ways

	TH390	TH402	TH399	TH200	TH211	TH631	TH370
Number poles ⁽¹⁾	2 3 poles	2 6 poles	2 6 poles	2 3 poles	2 4 poles	2 6 poles	2 poles
Wire cross-section	0.5 - 1.5 mm ²	0.5 - 4.0 mm ²	0.5 - 4.0 mm ²	0.5 - 1.5 mm ²	0.5 - 4.0 mm ²	0.5 - 4.0 mm ²	2.5 - 6.0 mm ²
Outer cable diameter ⁽²⁾	7.0 - 13.5 mm	7.0 - 20.0 mm	7.0 - 20.0 mm	7.5 - 9.5 mm	7.0 - 17.0 mm	7.0 - 14.0 mm	6.0 - 12.0 mm
IP protection degree	IP68	IP68	IP68	IP67	IP65	IP65	IP68



4 ways

	TH392	TH209*	TH623	TH624
Number poles ⁽¹⁾	2 4 poles	2 8 poles	2 3 poles	2 5 poles
Wire cross-section	0.5 4.0 mm ²	0.5 - 4.0 mm ²	0.5 - 4.0 mm ²	0.25 - 4.0 mm ²
Outer cable diameter ⁽²⁾	7.0 - 13.5 mm	7.0 - 14.0 mm	7.0 - 12.0 mm	7.0 - 13.5 mm
IP protection degree	IP68	IP66/IP68	IP68	IP68

* usable as a 3 way box with closure cap

Choose the connector that best suits your needs.

Wall mount connectors

Number poles⁽¹⁾

Wire cross-section

Outer cable diameter⁽²⁾

IP protection degree

Fixed connectors (re-accessible)



TH391

2 4 poles

0.5 - 4.0 mm²

7.0 - 13.5 mm

M20-M25

IP68/IP69K

Plug&Play connectors



TH381

2 poles

0.25 - 1.0 mm²

5.8 - 6.9 mm

M16

IP68/IP69K



TH387

2 5 poles

0.25 - 4.0 mm²

7.0 - 13.5 mm

M20-M25

IP66/IP68



TH385

2 3 poles

0.5 - 4.0 mm²

7.0 - 12.0 mm

M20-M25

IP66/IP68



TH406

2 6 poles

0.5 - 4.0 mm²

7.0 - 14.0 mm

M28

IP68

Circular and Linear connectors

Number poles⁽¹⁾

Wire cross-section

IP protection degree

Fixed connectors (re-accessible)



TH029

2 3 poles

0.5 - 4.0 mm²

IP00



TH032

2 4 poles

0.5 - 4.0 mm²

IP00



TH112

2 3 poles

0.5 - 1.5 mm²

IP54



TH021

2 5 poles

0.5 - 4.0 mm²

IP20



TH033

2 4 poles

0.5 - 4.0 mm²

IP00



Innovative cable glands in co-molding



TH450-451-452

Outer cable diameter⁽²⁾

4.0 - 17.0 mm

M16 - M20 - M25

PG9 - PG13.5 - PG16

IP protection degree

IP68

mini-TEETUBE®: mini in-line circular joint connectors (IP68/IP69K)



TH391

**TH391
xDRY®**

TH390

External dimensions (mm)	N. Poles min - max	Wire cross section min - max (mm ²)	Outer cable diameter min - max (mm)	Code	Cable Type (not exhaustive)	Technical data	IP Grade	Series	Pieces/box
ø23 x 68	2 - 3 - 4	0.5 - 4.0	7.0 - 12.0	SHORT VERSION THB.391.A4A	max. 4G1.5 FG7OR max. 4G1.5 - 3G2.5 - 2G4 H07RN-F	32A - 450V	IP68 (30m/2h)	TH391	200
ø23 x 95	2 - 3 - 4	0.5 - 4.0	7.0 - 13.5	LONG VERSION THB.391.A4A.L	max. 4G2.5 FG7OR max. 4G4 H07RN-F	32A - 450V	IP68/IP69K (30m/2h)	TH391	200
ø23 x 85	2 - 3 - 4	0.5 - 4.0	7.0 - 12.0	SHORT VERSION THB.391.R4A⁽¹⁾	max. 4G1.5 FG7OR max. 4G1.5 - 3G2.5 - 2G4 H07RN-F	17.5A - 450V	IP68 (30m/2h)	TH391	100
ø23 x 113	2 - 3 - 4	0.5 - 4.0	7.0 - 13.5	LONG VERSION THB.391.R4A.L⁽¹⁾	max. 4G2.5 FG7OR max. 4G4 H07RN-F	17.5A - 450V	IP68/IP69K (30m/2h)	TH391	100
ø32 x 82	2 - 3	0.5 - 4.0	7.0 - 13.5	THB.390.A1A	max. 3G4 FG7OR max. 3G4 H07RN-F	32A - 450V	IP68 (50m/1h)	TH390	200

(1) xDRY product with the anti-condensation barrier (see page 4)

TEETUBE®: in-line circular joint connectors (IP68/IP69K)



TH400

External dimensions (mm)	N. Poles min - max	Wire cross section min - max (mm ²)	Outer cable diameter min - max (mm)	Code	Cable Type (not exhaustive)	Technical data	IP Grade	Series	Pieces/box
ø32 x 130	2 - 3	0.5 - 4.0	7.0 - 13.5	THB.400.C1A⁽¹⁾	max. 3G4 FG7OR max. 3G4 H07RN-F	32A - 450V	IP68/IP69K (50m/1h)	TH400	200
			8.0 - 17.0	THB.400.D1N					
ø32 x 130	2 - 3 - 4	0.5 - 4.0	7.0 - 13.5	THB.400.D1G⁽²⁾	max. 4G4 FG7OR max. 4G4 H07RN-F	32A - 450V	IP68/IP69K (50m/1h)	TH400	200
			8.0 - 17.0	THB.400.D1B					
ø32 x 130	2 - 3 - 4	2.5 - 6.0	7.0 - 13.5	THB.400.D4A⁽²⁾	max. 4G6 FG7OR max. 4G6 H07RN-F	41A - 750V	IP68/IP69K (50m/1h)	TH400	200
			11.0 - 16.0	THB.400.D4C					
ø32 x 130	2 - 3 - 4	0.5 - 4.0	16.0 - 20.0	THB.400.D4E	max. 5G4 FG7OR max. 5G4 H07RN-F	32A - 450V	IP68/IP69K (50m/1h)	TH400	200
			7.0 - 13.5	THB.400.D1H⁽²⁾					
ø32 x 130	2 - 3 - 4 - 5	0.5 - 4.0	8.0 - 17.0	THB.400.D1A	max. 6G2.5 FG7OR max. 6G2.5 H07RN-F	32A - 450V	IP68/IP69K (50m/1h)	TH400	200
ø32 x 130	2 - 3 - 4 - 5 - 6	0.5 - 4.0	7.0 - 13.5	THB.400.D1L⁽²⁾					
			8.0 - 17.0	THB.400.D1D					

(1) External dimensions: ø26.5 mm x 115 mm (2) External dimensions: ø32 mm x 115 mm

mini-TEETUBE®: mini circular junction connectors - 3/4 ways "H" (IP68)



TH392

**TH392
(3 vie)**

**TH392
xDRY®**

External dimensions (mm)	N. Poles min - max	Wire cross section min - max (mm ²)	Outer cable diameter min - max (mm)	Code	Cable Type (not exhaustive)	Technical data	IP Grade	Series	Pieces/box
28 x 54 x 80	2 - 3 - 4	0.5 - 4.0	main 7.0 - 12.0 branch 7.0 - 12.0	SHORT VERSION THB.392.A4A	max. 4G1.5 FG7OR max. 4G1.5 H07RN-F	17.5A - 450V	IP68 (30m/2h)	TH392	50
			main 7.0 - 12.0 branch 7.0 - 12.0	SHORT VERSION THB.392.A4B⁽²⁾					
28 x 54 x 109	2 - 3 - 4	0.5 - 4.0	main 7.0 - 13.5 branch 7.0 - 13.5	LONG VERSION THB.392.A4A.L	max. 4G2.5 FG7OR max. 4G2.5 H07RN-F	17.5A - 450V	IP68 (30m/2h)	TH392	50
			main 7.0 - 13.5 branch 7.0 - 13.5	LONG VERSION THB.392.A4B.L⁽²⁾					
28 x 54 x 80	2 - 3 - 4	0.5 - 4.0	main 7.0 - 12.0 branch 7.0 - 12.0	SHORT VERSION THB.392.R4A⁽¹⁾	max. 4G1.5 FG7OR max. 4G1.5 H07RN-F	17.5A - 450V	IP68 (30m/2h)	TH392	50
			main 7.0 - 12.0 branch 7.0 - 12.0	SHORT VERSION THB.392.R4B^{(1) (2)}					
28 x 54 x 109	2 - 3 - 4	0.5 - 4.0	main 7.0 - 13.5 branch 7.0 - 13.5	LONG VERSION THB.392.R4A.L⁽¹⁾	max. 4G2.5 FG7OR max. 4G2.5 H07RN-F	17.5A - 450V	IP68 (30m/2h)	TH392	50
			main 7.0 - 13.5 branch 7.0 - 13.5	LONG VERSION THB.392.R4B.L^{(1) (2)}					

(1) xDRY product with the anti-condensation barrier (see page 4) (2) Version of 3 ways supplied with closure cap

TEETUBE®: circular junction connectors - 3 ways "T" (IP68)



TH390 "T"

External dimensions (mm)	N. Poles min - max	Wire cross section min - max (mm ²)	Outer cable diameter min - max (mm)	Code	Cable Type (not exhaustive)	Technical data	IP Grade	Series	Pieces/box
ø32 x 92 x 73	2 - 3	0.5 - 1.5	main 7.0 - 13.5 branch 7.0 - 13.5	THB.390.C1A	max. 3G1.5 FG70R max. 3G1.5 H07RN-F	32A - 450V	IP68 (20m/1h)	TH390	200
			main 7.0 - 13.5 branch 7.0 - 13.5	THB.402.C2E	max. 3G4 FG70R max. 3G4 H07RN-F				
ø32 x 92 x 121	2 - 3	0.5 - 4.0	main 7.0 - 13.5 branch 7.0 - 13.5	THB.402.D2E	max. 4G1.5 FG70R max. 4G1.5 H07RN-F	32A - 450V	IP68 (20m/1h)	TH402	200
			main 7.0 - 13.5 branch 8.0 - 17.0	THB.402.C1D					
ø32 x 92 x 121	2 - 3 - 4	0.5 - 1.5	main 7.0 - 13.5 branch 7.0 - 13.5	THB.402.D1D	max. 4G2.5 FG70R max. 4G2.5 H07RN-F	32A - 450V	IP68 (20m/1h)	TH402	200
			main 7.0 - 13.5 branch 8.0 - 17.0	THB.402.D4A					
ø32 x 92 x 121	2 - 3 - 4	1.5 - 4.0	main 7.0 - 13.5 branch 7.0 - 13.5	THB.402.D4C	max. 5G1.5 FG70R max. 5G1.5 H07RN-F	32A - 450V	IP68 (20m/1h)	TH402	200
			main 7.0 - 13.5 branch 11.0 - 16.0	THB.402.C1F					
ø32 x 92 x 121	2 - 3 - 4 - 5	0.5 - 1.5	main 7.0 - 13.5 branch 7.0 - 13.5	THB.402.D1F	max. 5G1.5 FG70R max. 5G1.5 H07RN-F	32A - 450V	IP68 (20m/1h)	TH402	200
			main 7.0 - 13.5 branch 8.0 - 17.0						



TH402

TEETUBE®: circular junction connectors - 3 ways "Y" (IP68)



TH399 (mini)

External dimensions (mm)	N. Poles min - max	Wire cross section min - max (mm ²)	Outer cable diameter min - max (mm)	Code	Cable Type (not exhaustive)	Technical data	IP Grade	Series	Pieces/box
ø32 x 63 x 125	2 - 3	0.5 - 1.5	main 7.0 - 13.5 branch 7.0 - 13.5	THB.399.E3A	max. 3G1.5 FG70R max. 3G1.5 H07RN-F	32A - 450V	IP68 (20m/1h)	TH399	200
			main 7.0 - 13.5 branch 7.0 - 13.5	THB.399.A9B	max. 3G4 FG70R max. 3G4 H07RN-F				
ø32 x 63 x 180	2 - 3	0.5 - 4.0	main 8.0 - 17.0 branch 8.0 - 17.0	THB.399.D9B	max. 4G1.5 FG70R max. 4G1.5 H07RN-F	32A - 450V	IP68 (20m/1h)	TH399	100
			main 7.0 - 13.5 branch 7.0 - 13.5	THB.399.A4A					
ø32 x 63 x 180	2 - 3 - 4	0.5 - 1.5	main 8.0 - 17.0 branch 8.0 - 17.0	THB.399.D4A	max. 4G4 FG70R max. 4G4 H07RN-F	32A - 450V	IP68 (20m/1h)	TH399	100
			main 7.0 - 13.5 branch 7.0 - 13.5	THB.399.A4E					
ø32 x 63 x 180	2 - 3 - 4	1.5 - 4.0	main 11.0 - 16.0 branch 11.0 - 16.0	THB.399.D4E	max. 5G1.5 FG70R max. 5G1.5 H07RN-F	32A - 450V	IP68 (20m/1h)	TH399	100
			main 7.0 - 13.5 branch 7.0 - 13.5	THB.399.A5A					
ø32 x 63 x 180	2 - 3 - 4 - 5	0.5 - 1.5	main 8.0 - 17.0 branch 8.0 - 17.0	THB.399.D5A		32A - 450V	IP68 (20m/1h)	TH399	100
			main 7.0 - 13.5 branch 7.0 - 13.5						



TH399

mini-TEETUBE®: mini wall mount circular joint connectors (IP68/IP69K)



TH391



Example

External dimensions (mm)	N. Poles min - max	Wire cross section min - max (mm ²)	Outer cable diameter min - max (mm)	Code ⁽¹⁾	Thread	Cable Type (not exhaustive)	Technical data	IP Grade	Series	Pieces/box
ø23 x 35	2 - 3 - 4	0.5 - 4.0	7.0 - 12.0	SHORT VERSION THB.391.B4A ⁽²⁾	M20	max. 4G1.5 FG70R max 4G1.5 - 3G2.5 - 2G4 H07RN-F	32A - 450V	IP68 (30m/2h)	TH391	200
ø23 x 50	2 - 3 - 4	0.5 - 4.0	7.0 - 13.5	LONG VERSION THB.391.B4A.L ⁽²⁾	M20	max. 4G2.5 FG70R max 4G4 H07RN-F	32A - 450V	IP68/IP69K (30m/2h)	TH391	200
ø23 x 48	2 - 3 - 4	0.5 - 4.0	7.0 - 12.0	SHORT VERSION THB.391.H4A	M20	max. 4G1.5 FG70R max 4G1.5 - 3G2.5 - 2G4 H07RN-F	32A - 450V	IP68 (30m/2h)	TH391	200
ø23 x 63	2 - 3 - 4	0.5 - 4.0	7.0 - 13.5	LONG VERSION THB.391.H4A.L	M20	max. 4G2.5 FG70R max 4G4 H07RN-F	32A - 450V	IP68/IP69K (30m/2h)	TH391	200
ø23 x 38	2 - 3 - 4	0.5 - 4.0	7.0 - 12.0	SHORT VERSION THB.391.L4A	M25	max. 4G1.5 FG70R max 4G1.5 - 3G2.5 - 2G4 H07RN-F	32A - 450V	IP68 (30m/2h)	TH391	200
ø23 x 53	2 - 3 - 4	0.5 - 4.0	7.0 - 13.5	LONG VERSION THB.391.L4A.L	M25	max. 4G2.5 FG70R max 4G4 H07RN-F	32A - 450V	IP68/IP69K (30m/2h)	TH391	200
ø23 x 53	2 - 3 - 4	0.5 - 4.0	7.0 - 12.0	SHORT VERSION THB.391.D4A ⁽²⁾⁽³⁾	M20	max. 4G1.5 FG70R max 4G1.5 - 3G2.5 - 2G4 H07RN-F	17.5A - 450V	IP68 (30m/2h)	TH391	100
ø23 x 68	2 - 3 - 4	0.5 - 4.0	7.0 - 13.5	LONG VERSION THB.391.D4A.L ⁽²⁾⁽³⁾	M20	max. 4G2.5 FG70R max 4G4 H07RN-F	17.5A - 450V	IP68/IP69K (30m/2h)	TH391	100
ø23 x 66	2 - 3 - 4	0.5 - 4.0	7.0 - 12.0	SHORT VERSION THB.391.N4A ⁽³⁾	M20	max. 4G1.5 FG70R 4G1.5 - 3G2.5 - 2G4 H07RN-F	17.5A - 450V	IP68 (30m/2h)	TH391	100
ø23 x 81	2 - 3 - 4	0.5 - 4.0	7.0 - 13.5	LONG VERSION THB.391.N4A.L ⁽³⁾	M20	max. 4G2.5 FG70R max 4G4 H07RN-F	17.5A - 450V	IP68/IP69K (30m/2h)	TH391	100
ø23 x 56	2 - 3 - 4	0.5 - 4.0	7.0 - 12.0	SHORT VERSION THB.391.T4A ⁽³⁾	M25	max. 4G1.5 FG70R 4G1.5 - 3G2.5 - 2G4 H07RN-F	17.5A - 450V	IP68 (30m/2h)	TH391	100
ø23 x 71	2 - 3 - 4	0.5 - 4.0	7.0 - 13.5	LONG VERSION THB.391.T4A.L ⁽³⁾	M25	max. 4G2.5 FG70R max 4G4 H07RN-F	17.5A - 450V	IP68/IP69K (30m/2h)	TH391	100

(1) Supplied with the fixing nut (2) Only for plastic panels or Class III (SELV) devices (3) xDRY product with the anti-condensation barrier (see page 4)

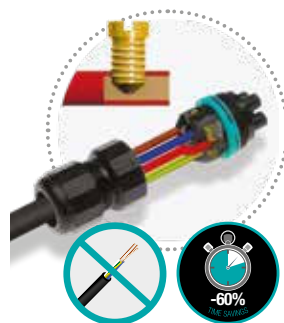

Products with piercing screw terminal blocks (see page 8)

In addition to products with screw terminal blocks, piercing screw connectors are available for cable section from 0.5 mm² to 1.5mm² (max. 17.5A). Approved with PVC, Neoprene and FEP cables.

How to order CODE THP:xxx.xxx
example

THP.391.A4A
products with piercing screws

THB.391.A4A
products with standard screws



Transparent and colour versions upon customer request.



Compatible with cable protection systems and spiral tops.



Versions with over-molded cable upon customer request.



Special versions. Learn more on www.techno.it



Wide range of accessories for cables of various kind.

TEEBOX®: In-out junction box with terminal block (IP44)

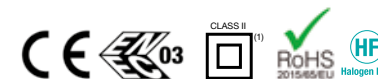

**TH110
(2poles)**

External dimensions (mm)	N. Poles min - max	Wire cross section min - max (mm ²)	Outer cable diameter min - max (mm)	Code	Cable Type (not exhaustive)	Technical data	IP Grade	Series	Pieces/box
75 x 39 x 13.5	2	0.5 - 2.5	5.0 - 9.0	THB.110.C2B⁽¹⁾	max. 2G2.5 - 3G2.5 H05SS-F, H05VV-F, H05RR-F	24A - 450V	IP44	TH110	600
75 x 39 x 13.5	3	0.5 - 2.5	5.0 - 9.0	THB.110.C3B		24A - 450V	IP44	TH110	600



**TH110
(3poles)**

(1) Approved for use with class 2 devices

TEEBOX®: Junction boxes with terminal block - 3 ways "T" (IP65/IP67)



TH200

External dimensions (mm)	N. Poles min - max	Wire cross section min - max (mm ²)	Outer cable diameter min - max (mm)	Code ⁽¹⁾	Cable Type (not exhaustive)	Technical data	IP Grade	Series	Pieces/box
70 x 82 x 20	2 - 3	0.5 - 1.5	main 7.5 - 9.5 branch 7.5 - 9.5	THB.200.E3F	max. 3G1.5 H07RN-F	16A - 250V	IP67	TH200	200
137 x 118 x 36	2 - 3	0.5 - 4.0	main 7.0 - 13.5 branch 7.0 - 13.5	THB.211.D3A	max. 3G4 FG70R max. 3G4 H07RN-F	24A - 450V	IP65	TH211	50
137 x 118 x 36	2 - 3	0.5 - 4.0	main 8.0 - 17.0 branch 8.0 - 17.0	THB.211.A3A	max. 3G4 FG70R max. 3G4 H07RN-F	24A - 450V	IP65	TH211	50
137 x 118 x 36	2 - 3 - 4	0.5 - 4.0	main 8.0 - 17.0 branch 8.0 - 17.0	THB.211.A4A	max. 4G4 FG70R max. 4G4 H07RN-F	16A - 450V	IP65	TH211	50



TH211

(1) Supplied with the terminal block Note: versions with more poles available upon request. Learn more on www.techno.it

TEEBOX®: Junction boxes with terminal block - 3/4 ways "H" (IP68)



TH209

External dimensions (mm)	N. Poles min - max	Wire cross section min - max (mm ²)	Outer cable diameter min - max (mm)	Code ⁽¹⁾	Cable Type (not exhaustive)	Technical data	IP Grade	Series	Pieces/box
108 x 65 x 28	2 - 3	0.5 - 4.0	main 7.0 - 14.0 branch 7.0 - 14.0	THB.209.A3A⁽²⁾	max. 3G4 FG70R max. 3G4 H07RN-F	24A - 450V	IP68 (5m/3h)	TH209	100
108 x 65 x 28	2 - 3 - 4	0.5 - 4.0	main 7.0 - 14.0 branch 7.0 - 14.0	THB.209.A4A	max. 4G2.5 FG70R max. 4G2.5 H07RN-F	24A - 450V	IP68 (5m/3h)	TH209	100
108 x 65 x 28	5	0.5 - 4.0	main 7.0 - 14.0 branch 7.0 - 14.0	THB.209.A5A	max. 5G1.5 FG70R max. 5G1.5 H07RN-F	16A - 450V	IP68 (5m/3h)	TH209	100
108 x 65 x 28	8	0.5 - 4.0	main 7.0 - 14.0 branch 7.0 - 14.0	THB.209.A8A	max. 8G1 H07RN-F	16A - 450V	IP68 (5m/3h)	TH209	100
108 x 65 x 28	-	-	main 7.0 - 14.0 branch 7.0 - 14.0	THA.219.A1A⁽³⁾	-	16A - 450V	IP68 (5m/3h)	TH209	100



TH219

(1) Supplied with the terminal block (2) Version of 3 ways supplied with closure cap (3) Empty box to be filled with the resin (resin not included)

TEEBOX®: Pre-wired junction boxes with plug&socket connectors 3 ways "T" (IP65)



TH631

External dimensions (mm) ⁽²⁾	N. Poles min - max	Wire cross section min - max (mm ²)	Outer cable diameter min - max (mm)	Code ⁽¹⁾	Cable Type (not exhaustive)	Technical data	IP Grade	Series	Pieces/box
235 x 159 x 43	2 - 3	0.5 - 4.0	main 7.0 - 14.0 branch 7.0 - 14.0	THH.631.B3A	max. 3G2.5 FG70R max. 3G2.5 H07RN-F	25A - 400V	IP65	TH631	50
235 x 159 x 43	2 - 3 - 4 - 5	0.5 - 4.0	main 7.0 - 14.0 branch 7.0 - 14.0	THH.631.B5A	max. 5G1.5 FG70R max. 5G1.5 H07RN-F	17.5A - 400V	IP65	TH631	50

(1) Supplied with plug&socket connectors (2) Dimensions are intended when the connectors are inserted



Example

TEEBOX®: Pre-wired junction boxes with plug&socket connectors 4 ways "H" (IP40/IP66/IP68)



TH623

External dimensions (mm) ⁽²⁾	N. Poles min - max	Wire cross section min - max (mm ²)	Outer cable diameter min - max (mm)	Code	Cable Type (not exhaustive)	Technical data	IP Grade	Series	Pieces/box
200 x 65 x 28	2 - 3	0.5 - 4.0	main 7.0 - 9.5 branch 7.0 - 9.5	THH.623.B3A ⁽¹⁾	max. 3G1.5 FG70R max. 3G1.5 H07RN-F	17.5A - 400V	IP40	TH623	50
200 x 65 x 28	2 - 3	0.5 - 4.0	main 7.0 - 12.0 branch 7.0 - 12.0	THH.623.L3A ⁽¹⁾	max. 3G2.5 FG70R max. 3G2.5 H07RN-F	17.5A - 400V	IP66/IP68 (5m/3h)	TH623	50
135 x 60 x 23	2 - 3 - 4		see TH387	THH.624.A4A ⁽³⁾	see TH387	17.5A - 400V	IP68	TH624	50
135 x 60 x 23	2 - 3 - 4 - 5		see TH387	THH.624.A5A ⁽³⁾	see TH387	17.5A - 400V	IP68	TH624	50
134 x 39 x 16	2		see TH381	THH.625.A2A ⁽³⁾	see TH381	10A - 400V	IP68	TH625	50

(1) Supplied with plug&socket connectors (2) Dimensions are intended when the connectors are inserted (3) Connectors must be ordered separately (series TH387)

Example

TH624



Products with piercing screw terminal blocks (see page 8)

In addition to products with screw terminal blocks, piercing screw connectors are available for cable section from 0.5 mm² to 1.5mm² (max. 17.5A). Approved with PVC, Neoprene and FEP cables.

How to order CODE THP.xxx.xxx example

THP.391.A4A
products with piercing screws

THB.391.A4A
products with standard screws



Colour and personalized versions upon customer request.



Transparent versions for easy check of the connection.

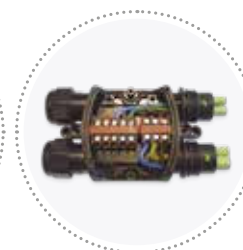







Hybrid and pre-wired solutions upon customer request.



Learn more about the TEEBOX® range on www.techno.it

mini-TEEPLUG®: mini plug&socket connectors (IP66/IP68/IP69K)





	External dimensions (mm) ⁽¹⁾	N. Poles min - max	Wire cross section min - max (mm ²)	Outer cable diameter min - max (mm)	Code	Connector type	Cable Type (not exhaustive)	Technical data	IP Grade	Series	Pieces/box
	ø14 x 95	2	0.25 - 1.0	5.8 - 6.9	THB.381.A2A ^{(3) (4)}	plug	max. 2G1 H05RN-F	10A - 400V	IP68/IP69K (30m/1h)	TH381	200
					THB.381.B2A ^{(3) (4)}	socket					200
	ø27 x 95	2 - 3	0.5 - 4.0	7.0 - 12.0	THB.384.A1A ⁽³⁾	plug	max. 3G2.5 FG70R max. 3G2.5 H07RN-F	17.5A - 400V	IP66/IP68 (50m/24h)	TH384	200
					THB.384.B1A ⁽³⁾	socket					200
	ø23 x 85	2 - 3 - 4	0.5 - 4.0	7.0 - 12.0	THB.387.A4A ⁽³⁾	plug	max. 3G2.5/4G1.5 FG70R max. 3G2.5/4G1.5 H07RN-F	17.5A - 450V	IP68 (30m/3h)	TH387	200
					THB.387.B4A ⁽³⁾	socket					200
	ø23 x 113	2 - 3 - 4	0.5 - 4.0	7.0 - 13.5	THB.387.A4A.L ⁽³⁾	plug	max. 4G2.5 FG70R max. 4G2.5 H07RN-F	17.5A - 450V	IP68/IP66 (30m/3h)	TH387	200
					THB.387.B4A.L ⁽³⁾	socket					200
	ø23 x 85	2 - 3 - 4 - 5	0.25 - 2.5	7.0 - 12.0	THB.387.A5A	plug	max. 5G1.5 FG70R max. 5G1.5 H07RN-F	17.5A - 450V	IP68 (30m/3h)	TH387	200
					THB.387.B5A	socket					200
	ø23 x 113	2 - 3 - 4 - 5	0.25 - 2.5	7.0 - 13.5	THB.387.A5A.L	plug	max. 5G2.5 FG70R max. 5G2.5 H07RN-F	17.5A - 450V	IP68/IP66 (30m/3h)	TH387	200
					THB.387.B5A.L	socket					200

(1) Dimensions are intended when the connectors are inserted (2) UL approvals only for the TH384 series – 3 poles, TH387 series – 4/5 poles (learn more on www.techno.it)

(3) Approved for use with class 2 devices (only for 2 poles versions) (4) For larger cable diameter see more on www.techno.it

TEEPLUG®: plug&socket connectors with safety lock-unlock system (IP68)



	External dimensions (mm) ⁽¹⁾	N. Poles min - max	Wire cross section min - max (mm ²)	Outer cable diameter min - max (mm)	Code	Connector type	Cable Type (not exhaustive)	Technical data	IP Grade	Series	Pieces/box
	ø36.5 x 130	2 - 3	0.5 - 4.0	7.0 - 14.0	THB.405.A2B ⁽⁴⁾	plug	max. 3G2.5 FG70R max. 3G2.5 H07RN-F	25A - 400V	IP68 (10m/1h)	TH405	200
					THB.405.B2B ⁽⁴⁾	socket					200
	ø36.5 x 130	2 - 3 - 4 - 5	0.5 - 4.0	7.0 - 14.0	THB.405.A2A	plug	max. 5G1.5 FG70R max. 5G1.5 H07RN-F	17.5A - 400V	IP68 (10m/1h)	TH405	200
					THB.405.B2A	socket					200
	ø36.5 x 130	2 - 3 - 4 - 5 - 6	0.5 - 4.0	7.0 - 14.0	THB.405.A2E	plug	max. 6G1.5 FG70R max. 6G1.5 H07RN-F	17.5A - 400V	IP68 (10m/1h)	TH405	200
					THB.405.B2E	socket					200

(1) Dimensions are intended when the connectors are inserted (2) UL approvals only for 3 and 5 poles (learn more on www.techno.it)

(3) Approved for use with class 2 devices (only for 2 poles versions) (4) Tested up to 32 Amp with 3G4 cable

TEEPLUG®: plug&socket connectors (IP65)



TH404

External dimensions (mm) ⁽¹⁾	N. Poles min - max	Wire cross section min - max (mm ²)	Outer cable diameter min - max (mm)	Code	Connector type	Cable Type (not exhaustive)	Technical data	IP Grade	Series	Pieces/box
ø42 x 130	2 - 3	0.5 - 4.0	7.0 - 14.0	THB.404.A2B	plug	max. 3G2.5 FG70R	25A - 400V	IP65	TH404	200
				THB.404.B2B	socket	max. 3G2.5 H07RN-F				200
ø42 x 130	2 - 3 - 4 - 5	0.5 - 4.0	7.0 - 14.0	THB.404.A2A	plug	max. 5G1.5 FG70R	17.5A - 400V	IP65	TH404	200
				THB.404.B2A	socket	max. 5G1.5 H07RN-F				200
ø42 x 130	2 - 3 - 4 - 5 - 6	0.5 - 4.0	7.0 - 14.0	THB.404.A2E	plug	max. 6G1.5 FG70R	17.5A - 400V	IP65	TH404	200
				THB.404.B2E	socket	max. 6G1.5 H07RN-F				200

(1) Dimensions are intended when the connectors are inserted (2) Approved for use with class 2 devices (only for TH404 series 2 poles)

mini-TEEPLUG®: mini wall mount plug&socket connectors (IP66/IP68/IP69K)



TH381

TH385

TH387

External dimensions (mm) ⁽¹⁾	N. Poles min - max	Wire cross section min - max (mm ²)	Code ⁽²⁾⁽³⁾	Thread	Technical data	IP Grade	Series	Pieces/box
ø14 x 95	2	0.25 - 1.0	THB.381.N2A	M16	10A - 400V	IP68/IP69K (30m/1h)	TH381	200
ø27 x 72	2 - 3	0.5 - 4.0	THB.385.A3D	M20	17.5A - 400V	IP66/IP68 (50m/24h)	TH385	200
ø27 x 72			THB.385.A1A	M25	17.5A - 400V	IP66/IP68 (50m/24h)	TH385	200
ø23 x (48÷63)	2 - 3 - 4	0.5 - 4.0	THB.387.L4A	M20 ⁽⁵⁾	17.5A - 450V	IP66/IP68 (30m/3h)	TH387	200
ø23 x (61÷76)			THB.387.N4A	M20	17.5A - 450V	IP66/IP68 (30m/3h)	TH387	200
ø23 x (51÷66)	2 - 3 - 4	0.5 - 4.0	THB.387.E4A	M25	17.5A - 400V	IP66/IP68 (30m/3h)	TH387	200
ø23 x (48÷63)			THB.387.L5A	M20 ⁽⁵⁾	17.5A - 450V	IP66/IP68 (30m/3h)	TH387	200
ø23 x (61÷76)	2 - 3 - 4 - 5	0.25 - 2.5	THB.387.N5A	M20	17.5A - 450V	IP66/IP68 (30m/3h)	TH387	200
ø23 x (51÷66)			THB.387.E5A	M25	17.5A - 450V	IP66/IP68 (30m/3h)	TH387	200

(1) Dimensions are intended when the connectors are inserted

(3) Supplied with the fixing nut

(5) Only for plastic panels or Class III (SELV) devices.

(2) Plug versions. For related socket versions see codes of the TH384 (for codes of TH385) and TH381, TH387.

(4) UL approvals only for TH385 M25 3 poles, TH387 M20 4/5 poles (learn more on www.techno.it)

(6) Approved for use with class 2 devices: only for TH385 2 poles, TH387 2 poles and TH381

Products with piercing screw terminal blocks (see page 8)

In addition to products with screw terminal blocks, piercing screw connectors are available for cable section from 0.5 mm² to 1.5mm² (max. 17.5A). Approved with PVC, Neoprene and FEP cables.

How to order CODE THP:xxx.xxx
example

THP.391.A4A
products with piercing screws

THB.391.A4A
products with standard screws



Colour and personalized versions upon request.



Transparent versions for easy check of the connection.



Versions with over-molded cable upon customer request.



Wide range of accessories for cables of various kind.

mini-TEEPLUG®: mini wall mount quick-fix plug&socket connectors (IP67)



TH386

Quick-fix system

External dimensions (mm) ⁽¹⁾	N. Poles min - max	Wire cross section min - max (mm ²)	Code ⁽²⁾	Panel Hole (mm)	Technical data	IP Grade	Series	Pieces/box
ø27 x 72	2 - 3	0.5 - 4.0	THB.386.A1A	ø25	17.5A - 400V	IP67	TH386	200

(1) Dimensions are intended when the connectors are inserted (2) Plug versions. For related socket versions see codes of the TH384 series

mini-TEEPLUG®: mini wall mount plug&socket connectors 90° angled (IP66/IP68)



TH385

With fixing nut

External dimensions (mm) ⁽¹⁾	N. Poles min - max	Wire cross section min - max (mm ²)	Code ⁽²⁾⁽³⁾	Thread	Technical data	IP Grade	Series	Pieces/box
ø27 x 35 x 100	2 - 3	0.5 - 4.0	THB.385.A3F	M20	17.5A - 400V	IP66/IP68 (50m/24h)	TH385	200

(1) Dimensions are intended when the connectors are inserted

(3) Supplied with the fixing nut

(2) Plug versions. For related socket versions see codes of the TH384 series

(4) Approved for use with class 2 devices (only for 2 poles versions)

TEEPLUG®: wall-mount plug&socket connectors (IP68)



TH406

With fixing nut

External dimensions (mm) ⁽¹⁾	N. Poles min - max	Wire cross section min - max (mm ²)	Code ⁽²⁾⁽³⁾	Thread	Technical data	IP Grade	Series	Pieces/box
ø36.5 x 70	2 - 3	0.5 - 4.0	THB.406.A1B	M28	25A - 400V	IP68 (10m/1h)	TH406	200
ø36.5 x 70	2 - 3 - 4 - 5	0.5 - 4.0	THB.406.A1A	M28	17.5A - 400V	IP68 (10m/1h)	TH406	200
ø36.5 x 70	2 - 3 - 4 - 5 - 6	0.5 - 4.0	THB.406.A1E	M28	17.5A - 400V	IP68 (10m/1h)	TH406	200

(1) Dimensions are intended when the connectors are inserted

(3) Supplied with the fixing nut

(5) Approved for use with class 2 devices (only for 2 poles versions)

(2) Plug versions. For related socket versions see codes of the TH405 serie

(4) UL approvals only for 3 and 5 poles (learn more on www.techno.it)

mini-TEEPLUG®: mini plug&socket connectors with insulation piercing system (IP68)

For single-pole main cables



TH370

External dimensions (mm) ⁽¹⁾	N. Poles min - max	Main cable cross section min - max (mm ²)	Main cable diameter min - max (mm)	Code	Technical data	IP Grade	Series	Pieces/box
32 x 44 x 130	2	2.5 - 4.0	6.0 - 7.0	THB.370.A2A ⁽²⁾	17.5A - 400V	IP68	TH370	200
32 x 44 x 130	2	4.0 - 6.0	7.0 - 8.0	THB.370.B2A ⁽²⁾	17.5A - 400V	IP68	TH370	200

(1) Dimensions are intended when the connectors are inserted (2) Socket versions. For the related plug version order the code THB.384.P2A

mini-TEEPLUG®: mini plug&socket ultra flat connector (IP67)



TH420

External dimensions (mm) ⁽¹⁾	N. Poles min - max	Main cable cross section min - max (mm ²)	Code ⁽²⁾	Technical data	IP Grade	Series	Pieces/box
22 x 84 x 4	2	0.75	THH.420.A2A	6A - 230V	IP67	TH420	200

(1) Dimensions are intended when the connectors are inserted (2) Plug and socket are supplied together

Note: plug and socket connectors are supplied with over-molded cable (H03V2V2-F, 2x0.75mm²). Cable length is 450 mm for both sides.

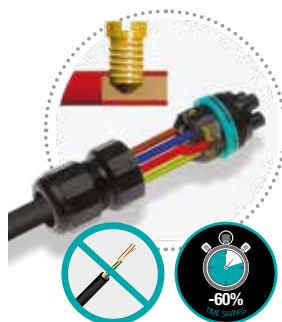

Products with piercing screw terminal blocks (see page 8)

In addition to products with screw terminal blocks, piercing screw connectors are available for cable section from 0.5 mm² to 1.5mm² (max. 17.5A). Approved with PVC, Neoprene and FEP cables.

How to order CODE THP:xxx.xxx
example

THP.391.A4A
products with piercing screws

THB.391.A4A
products with standard screws



TH386. Quick fixing on circular or flat panel without the use of the fixing nut.



TH386. Pluggable installation when used in combination with TH384 connectors.



TH370. Quick installations of the main cable with the insulation piercing clip connector.



TH370. Pluggable installation of the branch cable when used in combination with TH384 connectors.

TEEDRUM®: mini compact circular connectors (IP20)



TH021

External dimensions (mm)	N. Poles min - max	Wire cross section min - max (mm ²)	Code	Technical data	IP Grade	Series	Pieces/box
ø22 x 26	2 - 3	0.5 - 4.0	THB.021.A1A	32A - 450V	IP20	TH021	400
23 x 22 x 24	2 - 3 - 4	0.5 - 4.0	THB.033.A4A	32A - 450V	IP00	TH033	400
ø26 x 26	2 - 3 - 4 - 5	0.5 - 4.0	THB.021.B1A	32A - 450V	IP20	TH021	400



TH033



TEEBLOCK®: mini compact linear connectors (IP00)



TH026

External dimensions (mm)	N. Poles min - max	Wire cross section min - max (mm ²)	Code	Technical data	IP Grade	Series	Pieces/box
21 x 20.6 x 16.4	2 - 3	0.5 - 4.0	THB.026.B1A	32A - 450V	IP00	TH026	400
30.6 x 20.6 x 15.8	2 - 3	0.5 - 4.0	THB.029.A1A⁽¹⁾	32A - 450V	IP00	TH029	400
29 x 44 x 16	2 - 3	1.5 - 6.0	THC.027.A1A	41A - 450V	IP00	TH027	400
50.7 x 20.8 x 21	2 - 3 - 4	0.5 - 4.0	THB.032.A4B⁽¹⁾	32A - 450V	IP00	TH032	400
32 x 21 x 16.4	2 - 3 - 4 - 5	0.5 - 4.0	THB.026.A1A	32A - 450V	IP00	TH026	400



TH029



TH032

(1) Current distributor with double connection (see page 17) *Note: TEEBLOCK® connectors are approved for use with stranded and solid cables*

TEEBLOCK®: mini compact in-out terminal block with crimp/screw connection (IP54)



TH112

External dimensions (mm)	N. Poles min - max	Wire cross section min - max (mm ²)	Code	Technical data	IP Grade	Series	Pieces/box
21 x 46.3 x 12.6	2 - 3	0.5 - 1.5	THP.112.A3A	17.5A - 450V	IP54	TH112	400

Note: visit www.techno.it to learn more on crimp contacts usable with this product. See page 17 for more information on TH112

TEEGLAND®: innovative cable glands in co-molding (IP68)



Thread	Colour	Outer cable diameter (mm)	Code (cable gland)	Code (fixing nut) ⁽¹⁾	IP Grade	Series	Pieces/box
PG9	black	4.0 - 7.5	THA.450.A1A	6000046CC	IP68 (50m/1h)	TH450	500
PG9	black	7.5 - 9.5	THA.450.B1A	6000046CC	IP68 (50m/1h)		500
PG13.5	black	7.0 - 10.5	THA.451.B1A	604003200	IP68 (50m/1h)	TH451	500
PG13.5	black	10.5 - 14.0	THA.451.C1A	604003200	IP68 (50m/1h)	TH451	500
PG16	black	7.0 - 10.5	THA.451.B2A	6040050CC	IP68 (50m/1h)	TH451	500
PG16	black	10.5 - 14.0	THA.451.C2A	6040050CC	IP68 (50m/1h)	TH451	500
M16	black	4.0 - 7.5	THA.450.A0A	6000046CC	IP68 (50m/1h)		500
M16	black	7.5 - 9.5	THA.450.B0A	6000046CC	IP68 (50m/1h)	TH450	500
M20	black	7.0 - 10.5	THA.451.B0A	6000157CC	IP68 (50m/1h)	TH451	500
M20	black	10.5 - 14.0	THA.451.C0A	6000157CC	IP68 (50m/1h)	TH451	500
M25	black	7.0 - 10.5	THA.452.B1A	6000212CC	IP68 (50m/1h)	TH452	500
M25	black	10.5 - 14.0	THA.452.C1A	6000212CC	IP68 (50m/1h)	TH452	500
M25	black	14.0 - 17.0	THA.452.B0A	6000212CC	IP68 (50m/1h)	TH452	500



Thread	Colour	Outer cable diameter (mm)	Code (cable gland)	Code (fixing nut) ⁽¹⁾	IP Grade	Series	Pieces/box
PG9	grey	4.0 - 7.5	THA.450.A1E	6000046CC	IP68 (50m/1h)		500
PG9	grey	7.5 - 9.5	THA.450.B1E	6000046CC	IP68 (50m/1h)	TH450	500
PG13.5	grey	7.0 - 10.5	THA.451.B1E	604003200	IP68 (50m/1h)	TH451	500
PG13.5	grey	10.5 - 14.0	THA.451.C1E	604003200	IP68 (50m/1h)	TH451	500
PG16	grey	7.0 - 10.5	THA.451.B2E	6040050CC	IP68 (50m/1h)	TH451	500
PG16	grey	10.5 - 14.0	THA.451.C2E	6040050CC	IP68 (50m/1h)	TH451	500
M16	grey	4.0 - 7.5	THA.450.A0E	6000046CC	IP68 (50m/1h)		500
M16	grey	7.5 - 9.5	THA.450.B0E	6000046CC	IP68 (50m/1h)	TH450	500
M20	grey	7.0 - 10.5	THA.451.B0E	6000157CC	IP68 (50m/1h)	TH451	500
M20	grey	10.5 - 14.0	THA.451.C0E	6000157CC	IP68 (50m/1h)	TH451	500
M25	grey	7.0 - 10.5	THA.452.B1E	6000212CC	IP68 (50m/1h)	TH452	500
M25	grey	10.5 - 14.0	THA.452.C1E	6000212CC	IP68 (50m/1h)	TH452	500
M25	grey	14.0 - 17.0	THA.452.B0E	6000212CC	IP68 (50m/1h)	TH452	500

(1) The fixing nut is not included. To be ordered separately (black colour)



Colour versions available upon request.

Project references:

electrical connections under the most extreme conditions



Connection of LED industrial lighting for automotive industry (Germany).
Series TH405/TH406 (silicon free).



Connection of street lighting LED Luminaires (Rome, Italy).
Series TH405.



Connection of luminaires for Supertree Grove, Garden by the Bay (Singapore).
Series TH400.



Connection of facade lighting devices at Birmingham library (UK).
Series TH405/TH631.



Connection of LED luminaires (Penang, Malaysia).
Series TH387.



Connection of street lighting devices at F1 Grand Prix (Singapore).
Series TH405.



Connection of submersible pumps (France).
Series TH400.



Connection of lighting points on a sailing boat (New Zealand).
Series TH387.



Connection of LED luminaires in cold rooms on a FPSO vessel (Singapore).
Series TH387.



Connection of LED luminaires in a car washing plant (New Zealand).
Series TH387.



Wall mount connection on a control panel of a bottled water plant (Australia).
Series TH387.



Connection of liquid level sensors (Shanghai, China).
Series TH451.



Connection of generators for a server room UPS (New Zealand).
Series TH405.



Connection of motors (Germany).
Series TH450.



Connection of heating cables (Italy).
Series TH211.

International client experience

The industrial and creative process

From its *client experience* Techno has developed the innovative, complete and customized solution for electrical connections.

**FUNCTIONAL_CREATIVITY +
FOREFRONT_TECHNOLOGIES +
INNOVATIVE_MATERIALS =**

MORE RELIABLE AND AFFORDABLE SOLUTIONS

The continuous analysis of the application conditions and operational modalities in the factory and site over the last 10 years have enabled Techno to develop specific solutions which have become off-the-shelf products. This results in higher quality together with cheaper installation, maximum reliability and easy maintenance.

Techno continues to offer customizable products and, at the same time, it has strengthened its designing and productive structure to developed ad hoc customized solutions. With an Italian design and all the positive characteristics of "made in Italy" products.



Techno s.r.l.

Via Bancora e Rimoldi, 27
22070 Guanzate (CO), Italy
Ph. +39 031 976445

www.techno.it

Techno reserves the right to make any adjustments to the information contained herein at any time without notice. The dimensions and the specifications in this catalogue are for reference purpose only and are subject to change without notice. Consult Techno for the latest dimensions and design specifications or visit our web site www.techno.it

MADE IN ITALY